

PURA® NFC INVISIBLE (CONCEALED) HORIZONTAL FIXATION

Pura® NFC sidings, designed for use as external cladding, can be fixed invisibly using the Universal clip and matching SFS clip screw both available within the Pura® NFC portfolio. This fixing solution will result in a traditional halved joint overlap effect with horizontal orientation of the sidings.



Trespa provides these guidelines and all testing, code and design data for informational purposes only and advises that the customer, project owner, designer, architect and/or installer, seeks advice from independent (construction) professional and/or engineers regarding design, application and installation as well as compliance with design requirements, applicable codes, laws, regulations and test standards. Local codes, standards and applicable design requirements are to be consulted for proper use.

GENERAL INSTALLATION DETAILS

Utilizing the 'Rainscreen Principle', the Pura® NFC cladding system incorporates a ventilated cavity, providing continuous movement of air within the system to regulate temperature and aid in moisture evaporation and drainage.

Cavity depth and ventilation

For continuous ventilation behind the sidings, Trespa recommends the free air cavity depth between rainscreen cladding and the insulation or wall construction to be between 20 and 50 mm, in order to allow for ambient air to flow through from the ventilation inlets and outlets.

Ventilation inlets and outlets must be the equivalent of minimum 50 cm² per linear meter over the whole facade. Cavity depth as well as ventilation inlets and outlets must be in accordance with applicable building standards, regulations and certificates.

Subframe

Pura® NFC sidings must be installed on vertical oriented wooden battens or vertical oriented aluminum profiles. The subframe needs to be of sufficient strength and permanent durability. Design, quality and/or treatment of the subframe must be in accordance with applicable building standards, regulations and certificates.

Trespa further recommends the use of a flat EPDM gasket to the full width of vertical (wooden) battens of the subframe.

The width of the profiles of the subframe must be adapted to the design of the final facade. I.e. subframe must accommodate joint pattern. Create a cladding plan in advance to ensure framing positions are correct to match sidings fixing points.

- Jointing timber battens must be minimum 95 x 34 mm to accommodate 2 x clip fixings
- Intermediate timber battens must be minimum 45 x 34 mm to accommodate 1 x clip fixing
- Jointing aluminum profiles must have a minimum width of 100 mm to accommodate 2 x clip fixings
- Intermediate aluminum profiles must have a minimum width of 40 mm to accommodate 1 x clip fixings

When mounting on substructures, it is important to note that (metal) substructures change their dimensions in case of temperature differences. The dimensions of Pura® NFC also change ($\leq 0.25\%$) under the influence of changing temperatures and humidity. Therefore, during design, installation and fastening of the materials, sufficient clearance must be ensured in the system so that the sidings and the subframe can move accordingly.

GENERAL INSTALLATION DETAILS

Pura® NFC sidings can be fixed to the subframe by using the UNIVERSAL clip out of the Pura® NFC portfolio in combination with the SFS clip screw. UNIVERSAL clip and SFS clip screw are part of the Pura® NFC standard delivery programme.

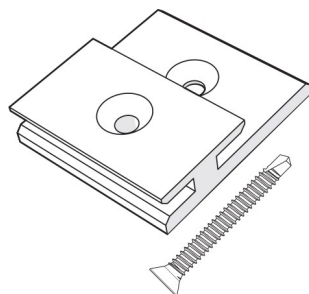

- UNIVERSAL clip - blank - Aluminum - 33.5 x 30 x 7.6 mm
- SFS clip screw - blank - type SDAW-S7/T20-3, 5 x 32-A2

The sidings must be installed from the bottom upwards. The UNIVERSAL clip in the first row must be mounted facing upwards. In all other rows the clip must be mounted facing downwards.

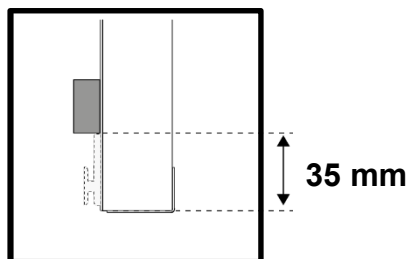

Clip facing upwards.

When mounting on a wooden subframe an installation bar can be used to align the first row of sidings. Installation bar should be aligned 35 mm from starting level.

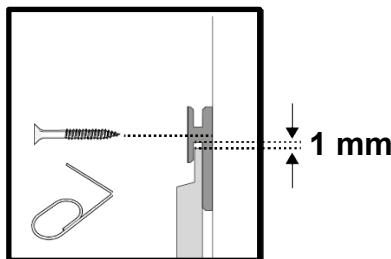

Clip facing downwards.

When mounting the UNIVERSAL clip make sure that the adjustment tool is used to ensure the 1 mm space between the top edge of the siding and the clip.

When mounting on an aluminum subframe alignment of the first row of UNIVERSAL clips should be done using a spirit level or laser tool.

When using HPL fast fixing screws or aluminium rivets consider edge clearance (top and bottom of siding as well as side of siding) of at least 20 mm and max. 10 x panel thickness.

GENERAL INSTALLATION DETAILS

Place two clips on the subframe where you want to make an intermediate joint. The width of the intermediate joint is minimum 8 mm.

Detail fixing points at vertical joints

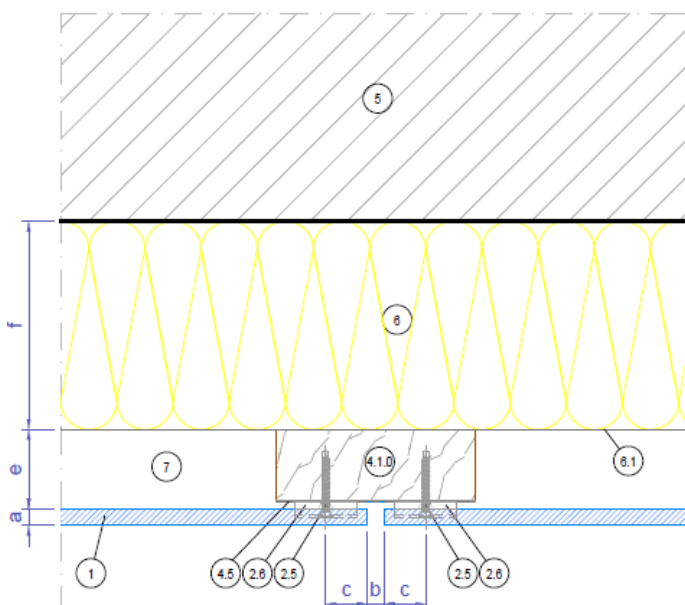

LEGEND:	
1	Pura® NFC panel
2.5	Counter sunk screw (SFS SDAW-S7/T20-3,5 x 32)
2.6	Universal clip
4.1.0	Vertical timber batten (min. 95 - 110 x 34 mm)
4.5	EPDM gasket
5	Wall
6	Insulation
6.1	(UV resistant) breather membrane (optional)
7	Ventilated cavity

GENERAL INFORMATION:	
a	Panel thickness 8 mm
	Joint width 8 mm.
b	Based on applicable building standards, regulations or certificates, wider joints may be permissible
c	Edge clearance min. 20 mm, max. 10 x panel thickness
	Ventilation min. 20 mm.
e	Recommended max. cavity depth (between rainscreen cladding and insulation): 50 mm.
	Ventilation inlets and outlets min. 50 cm ² /m
f	Insulation (thickness)

- The distance between the vertical battens should be max. 600 mm.
- To retain its position, each siding must have one fixed point. All other fixing points are sliding points.

Wooden subframe: Fixed point is created by using a flat head nail.

Aluminum subframe: Fixed point is created by using an adhesive bead (full width profiles). Double sided adhesive foam tape can be used to support during curing of the adhesive.

- Edge clearance for the clip needs to be considered as follows: minimum 20 mm / max 10 x siding thickness.

When using HPL fast fixing screws and/or rivets consider the same edge clearances. If the clip can not be used to fix the siding for the last row, sidings around window sills, soffits or other connections, need to be cut to size and HPL fast fixing screws or rivets have to be used to fix the siding. An installation ring or washer with self adhesives attached needs to be placed on the backside of the siding at the position of the drill hole.

Holes need to be drilled as follows:

- Wooden subframe: fixed point diameter 5 mm / sliding points diameter 8 mm
- Aluminum subframe: fixed point diameter 5.1 mm / sliding points diameter 10 mm

Horizontal cross-section wooden subframe

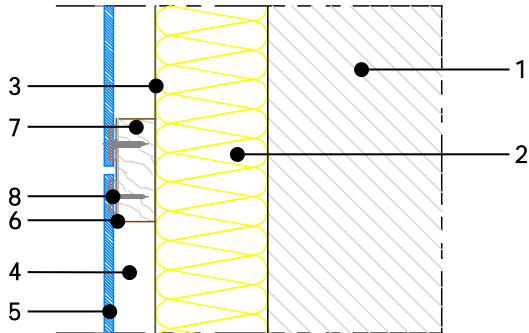

1. Load bearing wall (concrete, masonry)
2. Thermal insulation
3. Weather barrier (vapour permeable)
4. Ventilated cavity
5. Pura® NFC siding
6. EPDM gasket
7. Vertical timber batten
8. Universal Clip with counter sunk screw

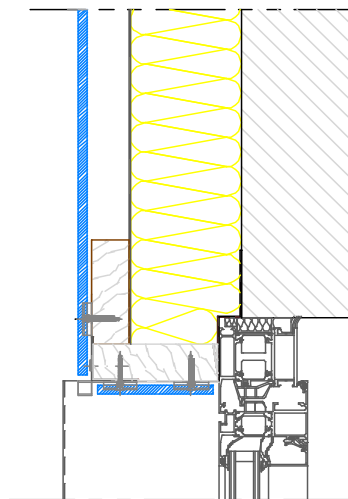
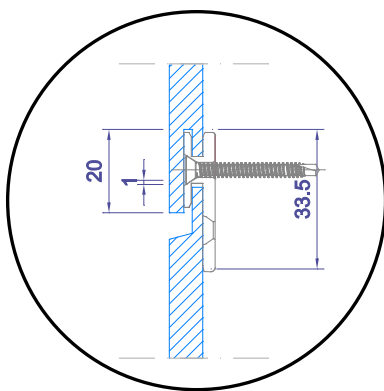
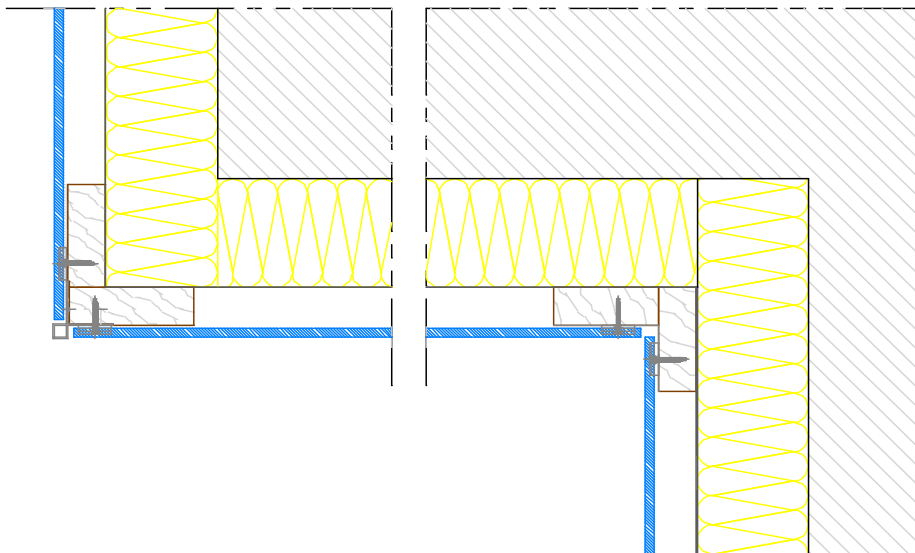

Vertical cross-section wooden subframe

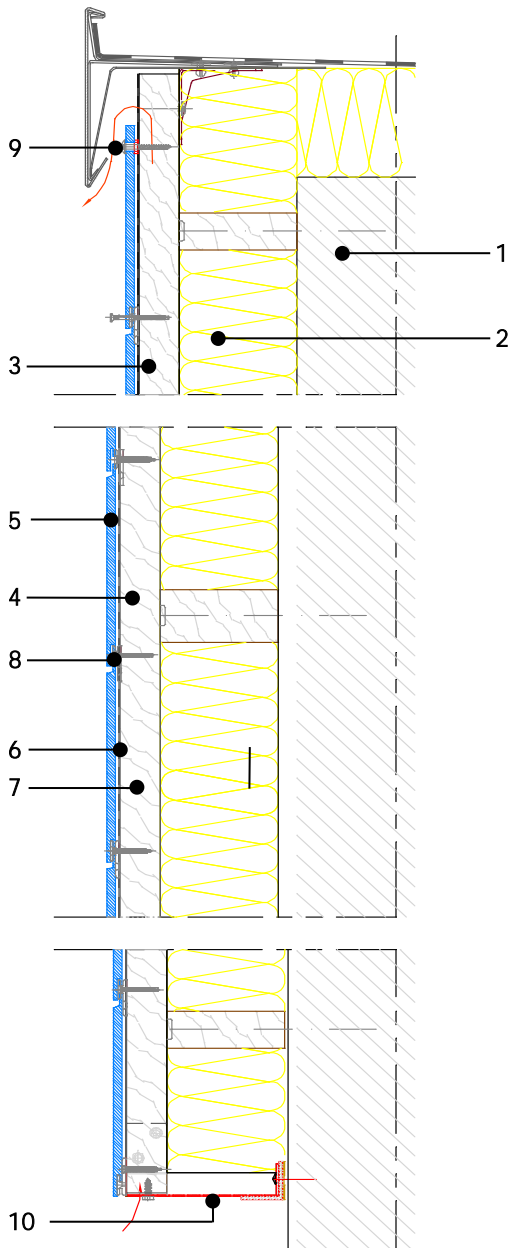

1. Load bearing wall (concrete, masonry)
2. Thermal insulation
3. Weather barrier (vapour permeable)
4. Ventilated cavity
5. Pura® NFC siding
6. EPDM gasket
7. Vertical timber batten
8. Universal Clip with counter sunk screw
9. Fast fix screw
10. Ventilation profile

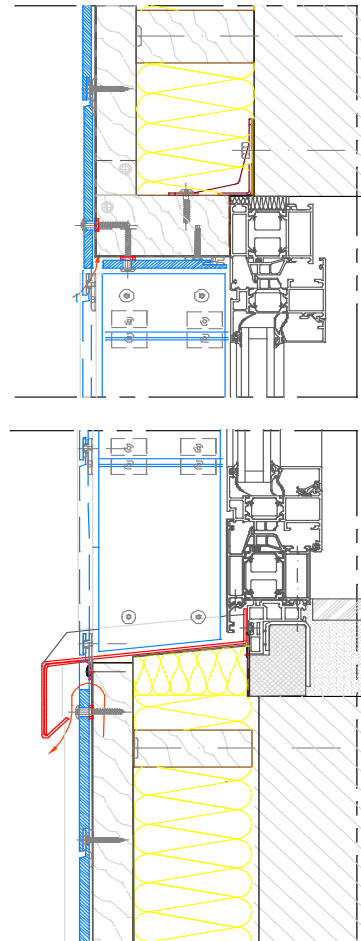

Horizontal cross-section aluminium subframe

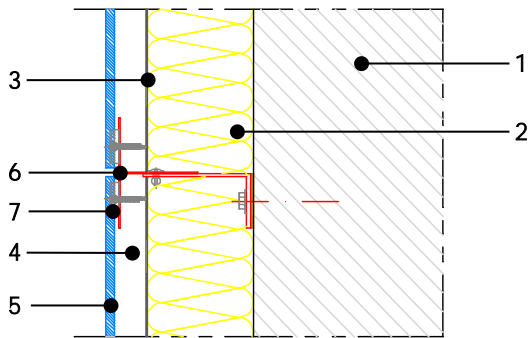

1. Load bearing wall (concrete, masonry)
2. Thermal insulation
3. Weather barrier (vapour permeable)
4. Ventilated cavity
5. Pura® NFC siding
6. Vertical aluminium profile
7. Universal Clip with counter sunk screw

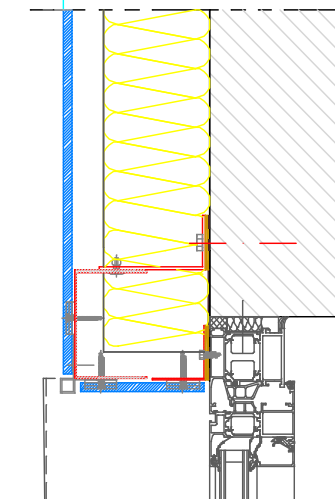
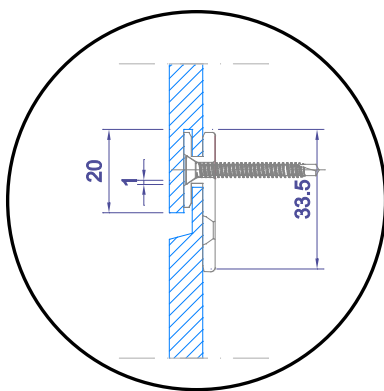
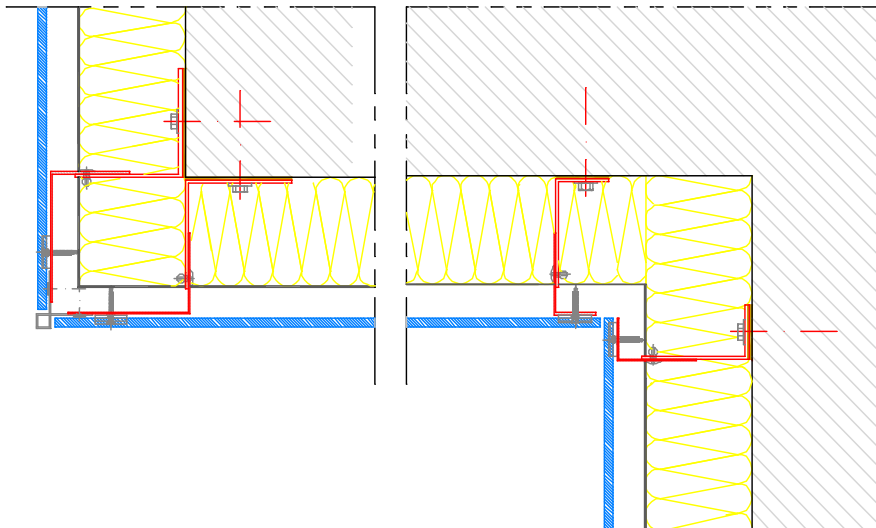

Vertical cross-section aluminium subframe

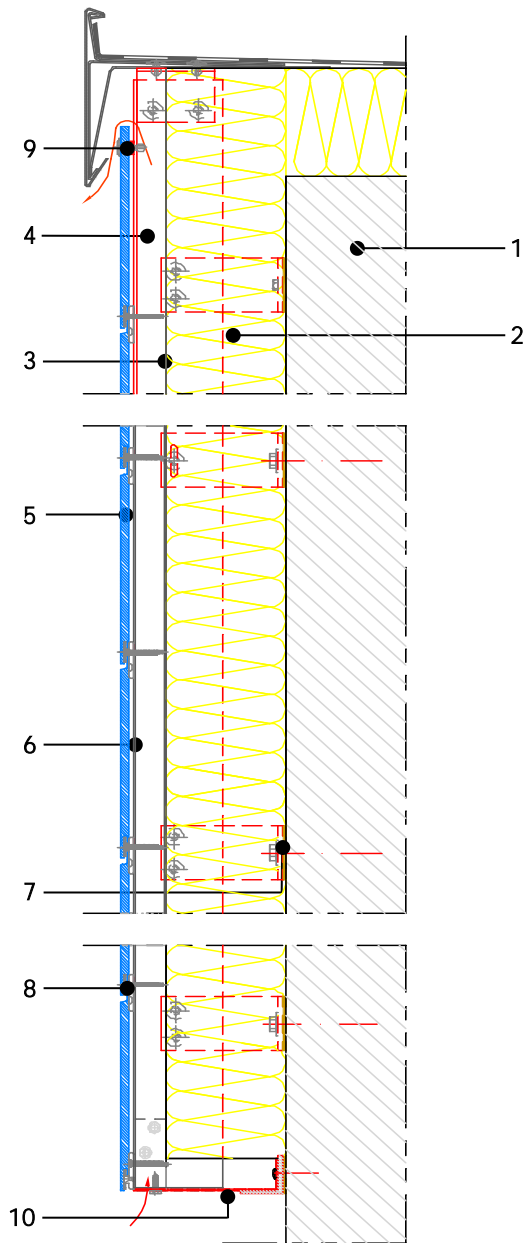

1. Load bearing wall (concrete, masonry)
2. Thermal insulation
3. Weather barrier (vapour permeable)
4. Ventilated cavity
5. Pura® NFC siding
6. Vertical aluminium profile
7. Wall bracket
8. Universal Clip with counter sunk screw
9. Aluminium rivet
10. Ventilation profile

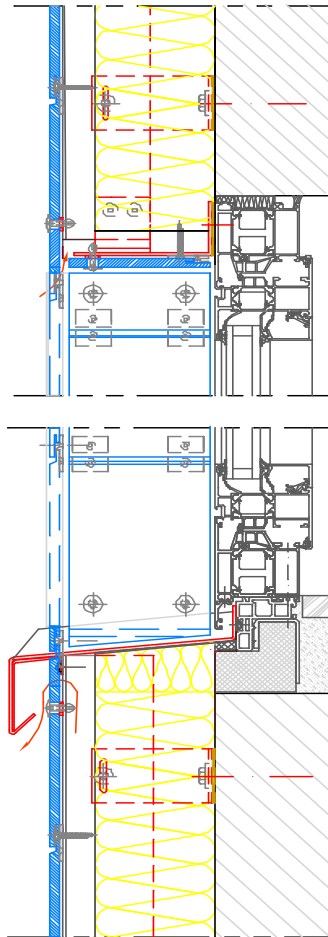

Disclaimer

This is a print generated by you from www.trespa.info ("Website"). By accessing the Website and printing this document you have accepted the Terms of Use of the Website. Please refer to the Website for all conditions that apply to this document. The system shown in this document may not be suitable for all applications and jurisdictions. We provide you with testing data and certification information for informational purposes only. We strongly recommend that you or any other user of this document obtains advice regarding compliance with design requirements, applicable codes, laws and regulations, and test standards from independent experts. Please check your local codes and design requirements for proper use. Trespa will not accept any liability in relation to your use of this document.

All intellectual property rights, including copyrights and other rights regarding the content of the Website and this print generated from the Website (including logos, trademarks, service marks, software, databases, audio, video, text and photographs) are owned by Trespa and/or its licensors. * Trespa, Meteon, Pura, Athlon, Izeon, TopLab, TopLab^{PLUS}, TopLab^{ECO-FIBRE}, TopLab^{VERTICAL}, TopLab^{BASE}, Trespa Essentials and Mystic Metallics, Virtuon, Volkern and Pura® NFC are registered trademarks of Trespa.

All oral and written statements, offers, quotations, sales, supplies, deliveries and/or agreements and all related activities of Trespa are governed by the Trespa General Terms and Conditions of Sale (Algemene verkoopvoorwaarden Trespa International B.V.) filed with the Chamber of Commerce (NL) on 20 February 2015 under number 24270677, which can be found on and downloaded from the Trespa website, www.trespa.com.

All oral and written statements, offers, quotations, sales, supplies, deliveries and/or agreements and all related work of Trespa North America, Ltd. are governed by the Trespa North America General Terms and Conditions of Sale, which can be found on and downloaded from the Trespa website, www.trespa.com/documentation. A copy of these general conditions of sale will be provided free of charge on request. All general terms and conditions other than the conditions mentioned above are dismissed and do not apply, regardless of whether such terms and conditions are referred to on requests for offers, offer confirmations, stationery and/or other documents of the other party, even if Trespa does not expressly object to such terms and conditions.